

Inductive sensor NRN40-L3K-E2-IO-V1

- 40 mm non-flush
- Reduction factor = 1
- Magnetic field resistant
- IO-Link interface for service and process data
- Switch point mode or window mode can be set
- Switching function, stability alarm and pulse extension can be set
- 4-way LED indicator
- Quick mounting bracket



Function

Reduction factor 1 sensors reliably detect different metals with the same switch state. The integrated IO-Link interface enables clear identification of the sensor and diagnosis of the sensor condition. When using the sensor, parameters and operating modes can be optimally configured specifically for the intended application. In addition to setting the switching function and a pulse extension, the user can select either switch point mode or window mode in combination with a stability alarm. In switch point mode, the stability alarm signals the detection of an object in the area between the assured operating distance and operating distance sn. In window mode, it signals the detection of an object below the window between operating distance sn and the nearest operating distance. A stability alarm is displayed to the user via a flashing LED and process data.

Dimensions

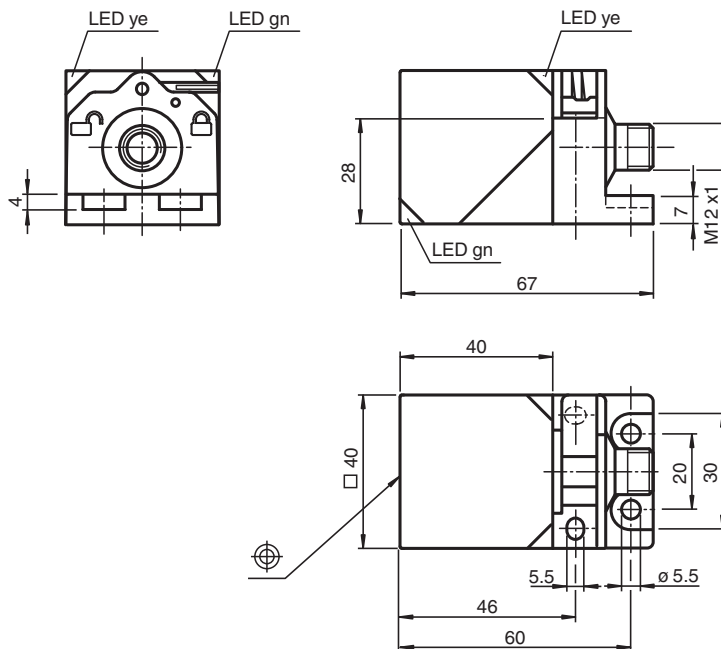

Technical Data

General specifications

Switching function	Normally open/closed (NO/NC) programmable
Output type	PNP

Technical Data

Rated operating distance	s_n	40 mm (factory setting)
Near operating distance		35 mm (can be activated by software)
Installation		non-flush
Output polarity		DC
Assured operating distance	s_a	0 ... 32.4 mm
Reduction factor r_{AI}		1
Reduction factor r_{Cu}		1
Reduction factor r_{304}		1
Reduction factor r_{Si37}		1
Output type		3-wire
Nominal ratings		
Operating voltage	U_B	10 ... 30 V DC
Switching frequency	f	0 ... 180 Hz (switch point mode) 0 ... 30 Hz (window mode, switch point mode with stability alarm)
Hysteresis	H	typ. 3 %
Reverse polarity protection		reverse polarity protected
Short-circuit protection		pulsing
Voltage drop	U_d	≤ 0.5 V
Operating current	I_L	0 ... 200 mA
Off-state current	I_r	0 ... 0.5 mA typ. 60 μ A at 25 °C
No-load supply current	I_o	≤ 20 mA
Time delay before availability	t_v	max. 150 ms
Constant magnetic field	B	200 mT
Alternating magnetic field	B	200 mT
Operating voltage indicator		LED, green
Status indicator		LED, yellow
Functional safety related parameters		
MTTF _d		701 a
Mission Time (T_M)		20 a
Diagnostic Coverage (DC)		0 %
Interface		
Interface type		IO-Link (via C/Q = pin 4)
IO-Link revision		1.1
Device ID		0x201002 (2101250)
Transfer rate		COM2 (38.4 kBit/s)
Min. cycle time		2.3 ms
Process data width		Process data input (control system side): 2 Bit Process data output (control system side): none
SIO mode support		yes
Compatible master port type		A
Compliance with standards and directives		
Standard conformity		
Standards		EN 60947-5-2:2007 EN 60947-5-2/A1:2012 IEC 60947-5-2:2007 IEC 60947-5-2 AMD 1:2012
Approvals and certificates		
Protection class		II
Rated insulation voltage	U_i	60 V
Rated impulse withstand voltage	U_{imp}	800 V
UL approval		cULus Listed, General Purpose Class 2 power source
CCC approval		CCC approval / marking not required for products rated ≤ 36 V
Ambient conditions		
Ambient temperature		-25 ... 70 °C (-13 ... 158 °F)

Release date: 2023-06-14 Date of issue: 2023-06-14 Filename: 306534-0004_eng.pdf

Technical Data

Storage temperature	-40 ... 85 °C (-40 ... 185 °F)
Mechanical specifications	
Connection type	Connector plug M12 x 1 , 4-pin
Housing material	GD-ZnAl4Cu1, coated mounting flange PA6-GF35
Sensing face	PA 6 Grivory GVN-35H
Degree of protection	IP67
Mass	190 g
Factory settings	
Default setting	operating mode = switch point mode with stability alarm switching function = Normally open (NO) switching distance = 40 mm

Connection

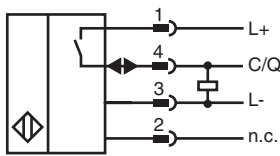

Connection Assignment

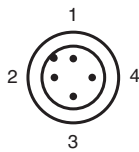

Wire colors in accordance with EN 60947-5-2

1		BN	(brown)
2		WH	(white)
3		BU	(blue)
4		BK	(black)

Release date: 2023-06-14 Date of issue: 2023-06-14 Filename: 306534-0004_eng.pdf

Function Principle

Switching output modes

Switch point mode at rated operating distance s_n

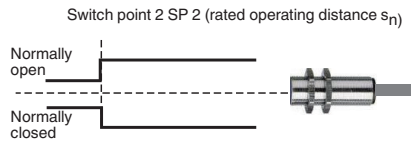

Switch point mode with near operating distance

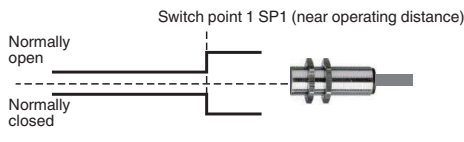

Window mode

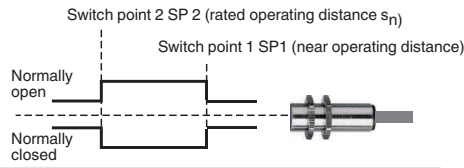

Stability alarm

Switch point mode with stability alarm (factory default)

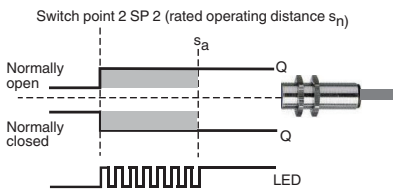

Window mode with stability alarm

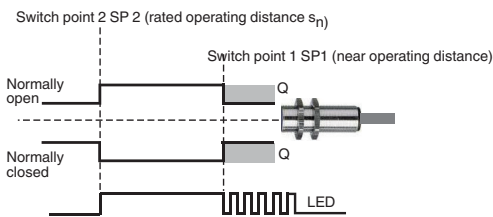













Release date: 2023-06-14 Date of issue: 2023-06-14 Filename: 306534-0004_eng.pdf

Accessories

	V1-G-2M-PVC	Female cordset single-ended M12 straight A-coded, 4-pin, PVC cable grey
	V1-W-2M-PVC	Female cordset, M12, 4-pin, PVC cable

Refer to "General Notes Relating to Pepperl+Fuchs Product Information".

Accessories

	MHW 01	Modular mounting bracket
	MH 02-L	Mounting aid for VariKont-L
	MH 04-2681F	Mounting aid for VariKont, +U1+ and +U9*
	ICE2-8IOL-G65L-V1D	EtherNet/IP IO-Link master with 8 inputs/outputs
	ICE3-8IOL-G65L-V1D	PROFINET IO IO-Link master with 8 inputs/outputs
	ICE2-8IOL-K45S-RJ45	EtherNet/IP IO-Link master with 8 inputs/outputs, DIN rail, screw terminal
	ICE3-8IOL-K45P-RJ45	PROFINET IO IO-Link master with 8 inputs/outputs, DIN rail, push-in terminals
	ICE3-8IOL-K45S-RJ45	PROFINET IO IO-Link master with 8 inputs/outputs, DIN rail, screw terminal
	IO-Link-Master02-USB	IO-Link master, supply via USB port or separate power supply, LED indicators, M12 plug for sensor connection
	ICE1-8IOL-G30L-V1D	Ethernet IO-Link module with 8 inputs/outputs
	ICE1-8IOL-G60L-V1D	Ethernet IO-Link module with 8 inputs/outputs
	ICE2-8IOL-K45P-RJ45	EtherNet/IP IO-Link master with 8 inputs/outputs, DIN rail, push-in connectors